



LIGITEK

LIGITEK ELECTRONICS CO.,LTD.
Property of Ligitek Only

SINGLE DIGIT LED DISPLAY (0.50 Inch)

LSD505/64-XX

DATA SHEET

DOC. NO : QW0905-LSD505/64-XX

REV. : A

DATE : 24 - Jan - 2005



Package Dimensions

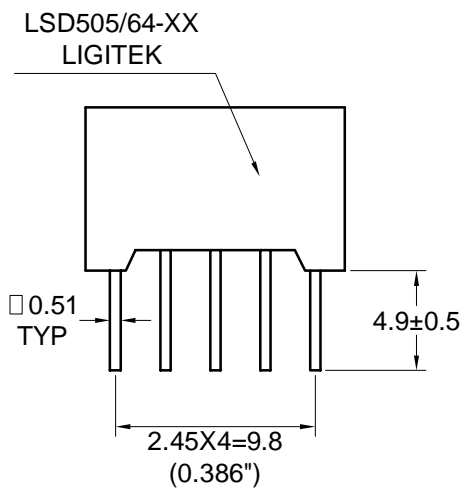
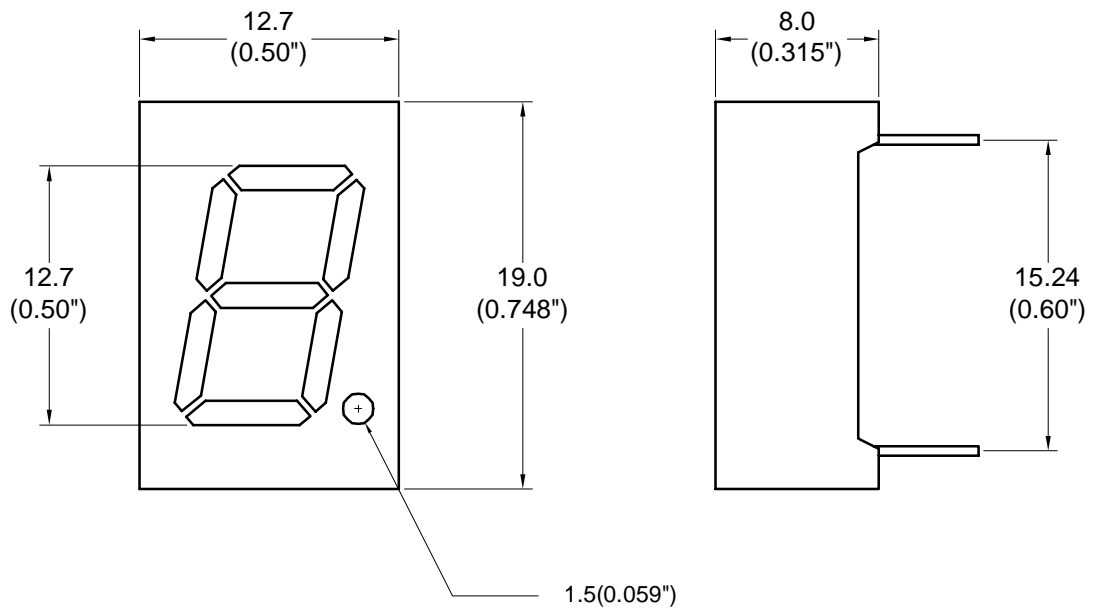

PIN NO.1 →

Note : 1.All dimension are in millimeters and (Inch) tolerance is ±0.25(0.01") unless otherwise noted.
2.Specifications are subject to change without notice.



Internal Circuit Diagram

LSD5054-XX

3,8

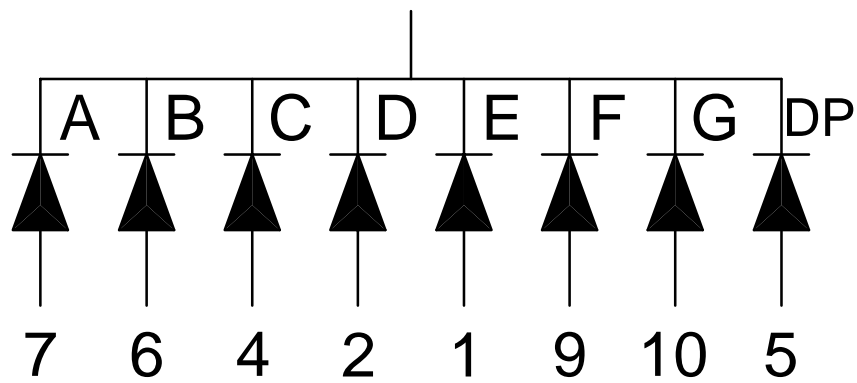

LSD5064-XX

3,8

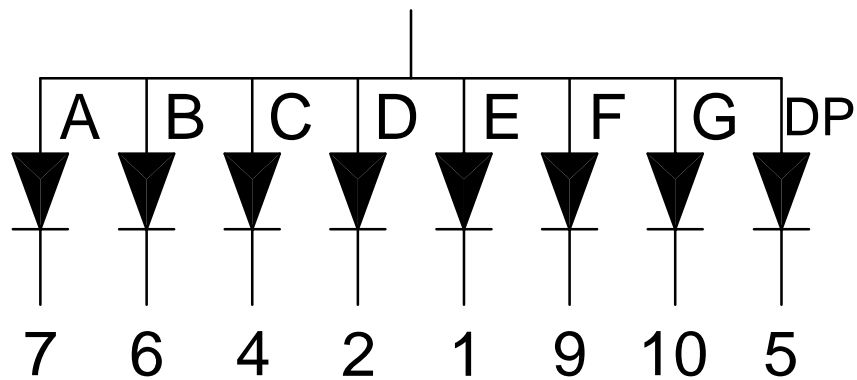



Electrical Connection

PIN NO.	LSD5054-XX	PIN NO.	LSD5064-XX
1	Anode E	1	Cathode E
2	Anode D	2	Cathode D
3	Common Cathode	3	Common Anode
4	Anode C	4	Cathode C
5	Anode DP	5	Cathode DP
6	Anode B	6	Cathode B
7	Anode A	7	Cathode A
8	Common Cathode	8	Common Anode
9	Anode F	9	Cathode F
10	Anode G	10	Cathode G



Absolute Maximum Ratings at Ta=25

Parameter	Symbol	Ratings	UNIT
		E	
Forward Current Per Chip	IF	30	mA
Peak Forward Current Per Chip (Duty 1/10,0.1ms Pulse Width)	IFP	120	mA
Power Dissipation Per Chip	PD	100	mW
Reverse Current Per Any Chip	Ir	10	μA
Operating Temperature	Topr	-25 ~ +85	
Storage Temperature	Tstg	-25 ~ +85	
Solder Temperature 1-16 Inch Below Seating Plane For 3 Seconds At 260			

Part Selection And Application Information(Ratings at 25)

PART NO	CHIP		common cathode or anode	P (nm)	(nm)	Electrical					IV-M
	Material	Emitted				Vf(v)			Iv(mcd)		
						Min.	Typ.	Max.	Min.	Typ.	
LSD5054-XX	GaAsP/GaP	Orange	Common Cathode	635	45	1.7	2.0	2.6	1.75	3.2	2:1
LSD5064-XX			Common Anode								

Note : 1.The forward voltage data did not including ±0.1V testing tolerance.
2. The luminous intensity data did not including ±15% testing tolerance.



Test Condition For Each Parameter

Parameter	Symbol	Unit	Test Condition
Forward Voltage Per Chip	Vf	volt	If=20mA
Luminous Intensity Per Chip	Iv	mcd	If=10mA
Peak Emission Wavelength	P	nm	If=20mA
Spectral Line Half-Width		nm	If=20mA
Reverse Current Any Chip	Ir	μ A	Vr=5V
Luminous Intensity Matching Ratio	IV-M		



Typical Electro-Optical Characteristics Curve

E CHIP

Fig.1 Forward current vs. Forward Voltage

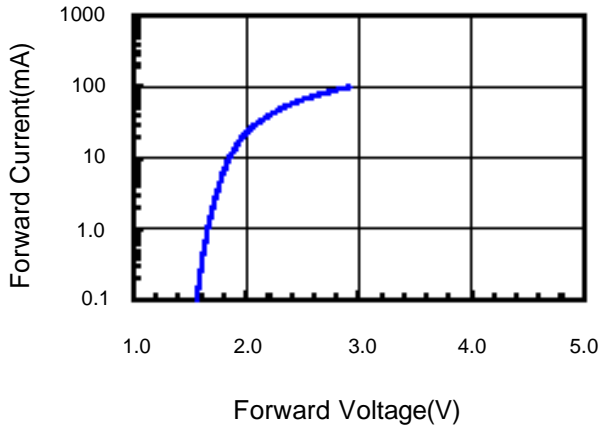

Fig.2 Relative Intensity vs. Forward Current

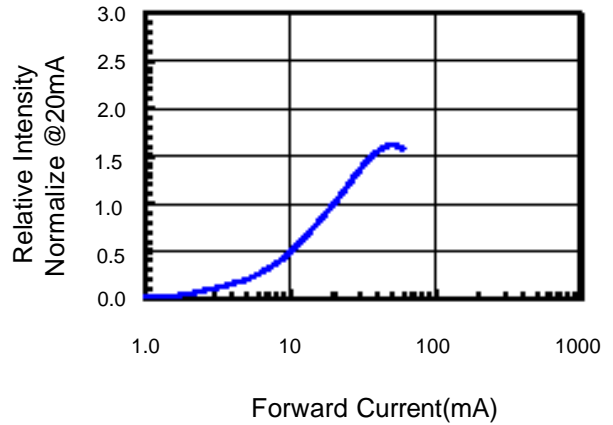

Fig.3 Forward Voltage vs. Temperature

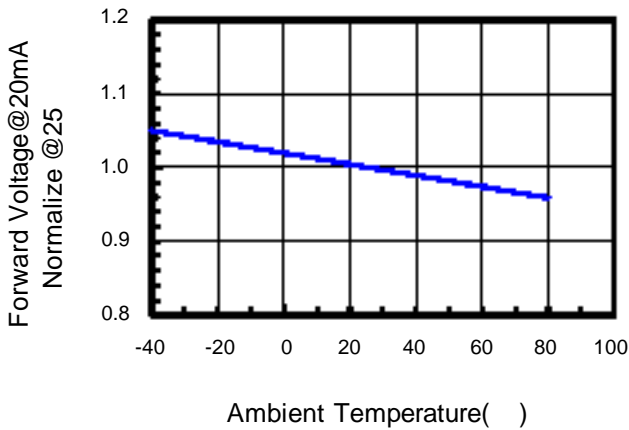

Fig.4 Relative Intensity vs. Temperature

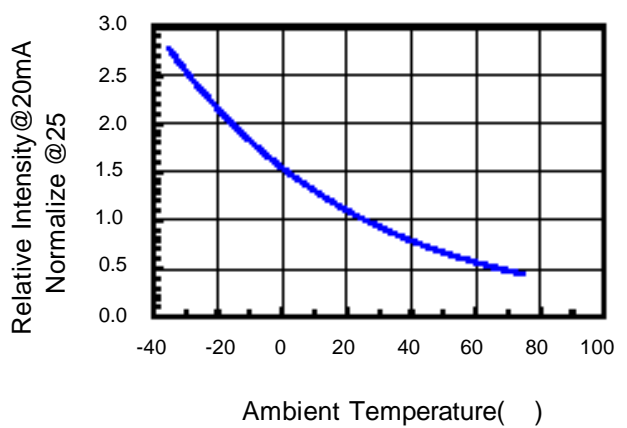
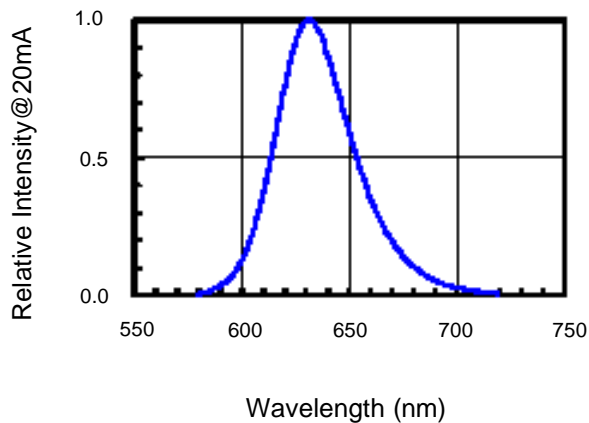

Fig.5 Relative Intensity vs. Wavelength



**Reliability Test:**

Test Item	Test Condition	Description	Reference Standard
Operating Life Test	1.Under Room Temperature 2.If=10mA 3.t=1000 hrs (-24hrs, +72hrs)	This test is conducted for the purpose of determining the resistance of a part in electrical and thermal stressed.	MIL-STD-750: 1026 MIL-STD-883: 1005 JIS C 7021: B-1
High Temperature Storage Test	1.Ta=105 ±5 2.t=1000 hrs (-24hrs, +72hrs)	The purpose of this is the resistance of the device which is laid under condition of high temperature for hours.	MIL-STD-883:1008 JIS C 7021: B-10
Low Temperature Storage Test	1.Ta=-40 ±5 2.t=1000 hrs (-24hrs, +72hrs)	The purpose of this is the resistance of the device which is laid under condition of low temperature for hours.	JIS C 7021: B-12
High Temperature High Humidity Test	1.Ta=65 ±5 2.RH=90%~95% 3.t=240hrs ±2hrs	The purpose of this test is the resistance of the device under tropical for hours.	MIL-STD-202:103B JIS C 7021: B-11
Thermal Shock Test	1.Ta=105 ±5 & -40 ±5 (10min) (10min) 2.total 10 cycles	The purpose of this is the resistance of the device to sudden extreme changes in high and low temperature.	MIL-STD-202: 107D MIL-STD-750: 1051 MIL-STD-883: 1011
Solder Resistance Test	1.T.Sol=260 ±5 2.Dwell time= 10 ±1sec.	This test intended to determine the thermal characteristic resistance of the device to sudden exposures at extreme changes in temperature when soldering the lead wire.	MIL-STD-202: 210A MIL-STD-750: 2031 JIS C 7021: A-1
Solderability Test	1.T.Sol=230 ±5 2.Dwell time=5 ±1sec	This test intended to see soldering well performed or not.	MIL-STD-202: 208D MIL-STD-750: 2026 MIL-STD-883: 2003 JIS C 7021: A-2